



HOVERSLING®

Split-Leg



HOVERSLING®

Repositioning Sheet

User Manual

































Visit www.HoverTechInternational.com for other languages

TABLE OF CONTENTS

Symbol Reference	2
Intended Use and Precautions.....	3
Part Identification – HoverSling® Split-Leg.....	4
HoverSling® Split-Leg Product Specifications/Required Accessories	4
HoverSling® Split-Leg Instructions for Use as a Transfer Mattress	5
HoverSling® Split-Leg Instructions for Use as a Sling	5-6
Part Identification – HoverSling® Repositioning Sheet	7
HoverSling® Repositioning Sheet Product Specifications/Required Accessories...	7
Attaching HoverSling® Repositioning Sheet Link Sling Straps	8
HoverSling® Repositioning Sheet Instructions for Use as a Transfer Mattress	8
HoverSling® Repositioning Sheet Instructions for Use as a Sling	8-9
HoverSling® Repositioning Sheet Instructions for Use for Seated Transfers.....	10
Part Identification – HT-Air® 1200 Air Supply.....	11
HT-Air® 1200 Air Supply Keypad Functions.....	11
Cleaning, Preventive Maintenance/Infection Control	12
Returns and Repairs.....	13

Symbol Reference

	CE MARKING OF CONFORMITY		LOT NUMBER
	UK MARKING OF CONFORMITY		MANUFACTURER
	AUTHORIZED REPRESENTATIVE		DATE OF MANUFACTURE
	UK RESPONSIBLE PERSON		MEDICAL DEVICE
	SWITZERLAND AUTHORIZED REPRESENTATIVE		MR CONDITIONAL
	CAUTION / WARNING		MR UNSAFE
	IMPORTER		SINGLE PATIENT - MULTIPLE USE
	DISPOSAL		DO NOT LAUNDRER
	OPERATING INSTRUCTIONS		UNIQUE DEVICE IDENTIFIER
	USE TWO CAREGIVERS		PATIENT WEIGHT LIMIT
	LOCK ALL WHEELS		STAY CLOSE APPROACH
	ENSURE PATIENT IS FLAT		DEFLATE, RAISE RAILS
	CENTER PATIENT		LOOP STYLE HANGER BAR
	FASTEN PATIENT STRAP		ATTACH CONNECTING STRAP
	LATEX FREE		FOOT END

HOVERSLING® User Manual



DECLARATION OF CONFORMITY

This product conforms to the requirements of Medical Devices Regulation (2017/745).
Further, this product conforms to the requirements of: ISO 10535

Intended Use and Precautions

INTENDED USE

The HoverSling® Split-Leg and HoverSling® Repositioning Sheet are combination air-assisted transfer mattresses and lift slings. When used as an air-assisted mattress, the HoverTech Air Supply inflates the HoverSling to cushion and cradle the patient, while air simultaneously escapes from the holes on the underside, reducing the force needed to move the patient by 80-90%. In this capacity, the HoverSling can be used to assist caregivers with lateral patient transfers, positioning (including boosting and turning), and proning. The HoverSling can also be used uninflated for vertical patient lifts, turning, and proning with a loop style hanger bar.

INDICATIONS

- Patients unable to assist in their own lateral or vertical transfer.
- Patients whose weight or girth poses a potential health risk for the caregivers responsible for repositioning, vertically transferring or laterally transferring said patients.

CONTRAINDICATIONS

- Patients who are experiencing thoracic, cervical or lumbar fractures that are deemed unstable should not use the HoverSling unless a clinical decision has been made by your facility.

INTENDED CARE SETTINGS

- Hospitals, long term or extended care facilities

PRECAUTIONS – FOR USE AS AN AIR-ASSISTED TRANSFER MATTRESS

- Caregivers must verify that all brakes have been engaged prior to transfer.
- Use a minimum of two caregivers during air-assisted lateral patient transfers.
- For in-bed air-assisted positioning tasks, more than one caregiver may need to be used. Side rails must be raised with one caregiver.
- For air-assisted proning, see HoverTech's video on www.HoverTechInternational.com.
- Never leave patient unattended on an inflated HoverSling.
- Only use the HoverSling for its intended purpose as described in this manual.
- Only use attachments and/or accessories that are authorized by HoverTech.
- When transferring to a low air loss bed, set the bed mattress air flow to the highest level for a firm transfer surface.
- Never attempt to move a patient laterally on an uninflated HoverSling.
- Ensure patient is centered on HoverSling before inflating.

PRECAUTIONS - AIR SUPPLY

- Route the power cord in a manner to ensure freedom from hazard. Avoid blocking the air intakes of the air supply.
- When using the HoverSling in the MRI environment, a 25 ft. specialty MRI hose is required (available for purchase).
- CAUTION: Avoid electric shock. Do not open air supply.
- Reference product specific user manuals for operating instructions.

PRECAUTIONS – FOR USE AS A SLING

- For lateral patient transfers, more than one caregiver may need to be used.
- For in-bed positioning tasks, more than one caregiver may need to be used. Side rails must be raised with one caregiver.
- For proning, see HoverTech's training video @ www.HoverTechInternational.com.
- The HoverSling should only be used by trained personnel.
- Only use attachments and/or accessories that are authorized by HoverTech.
- Before use, a risk assessment must be carried out to ensure that the correct size HoverSling is being used for the patient.
- A clinical assessment should be carried out by a qualified nurse and therapist before lifting patients with the HoverSling.
- Do not use the HoverSling Split-Leg lateral transfer handles to lift. Excessive force on the lateral transfer handles can cause the HoverSling to tear.
- Make sure the HoverSling is not attached to any object other than the loop style hanger bar.
- When connecting to loop style hanger bar, ensure shoulder strap loop colors match on the patient's left and right side and leg strap loop colors match on the patient's left and right side.
- Once the sling support straps are fully extended, make sure they are properly connected to the hanger bar before the patient is lifted.
- For seated lifts, make sure the patient is sitting securely in the HoverSling® before transferring or lifting.
- Never lift a patient higher than is necessary to complete the lift/transfer.
- Never leave the patient unattended while using the HoverSling.
- Use the HoverSling according to both the lift and HoverSling instructions.
- If the weight limit differs among the patient lift, hanger bar, and HoverSling, then the lowest weight limit applies.



If there is any indication of damage, remove the HoverSling from service and discard.



Side rails must be raised with one caregiver.



In the OR – To prevent patient from slipping, always deflate the HoverSling and secure the patient and HoverSling to the OR table prior to moving the table into an angled position.

PRECAUTIONS – MRI

- The HoverSling Split-Leg and HoverSling Repositioning Sheet are MR conditional by rationale. The devices are made from all non-ferrous materials. As a result, MR safety testing was not performed. Based on rationale, the HoverSling Split-Leg and HoverSling® Repositioning Sheet are electronically non-conductive and non-magnetic.
- When using a HoverSling Split-Leg and HoverSling Repositioning Sheet in an MRI environment a 25 ft. specialty MRI hose is required, thus making these products MR conditional. The HoverTech air supply and regular hose are conductive and magnetic and are MR Unsafe.

Part Identification – HoverSling® Split-Leg

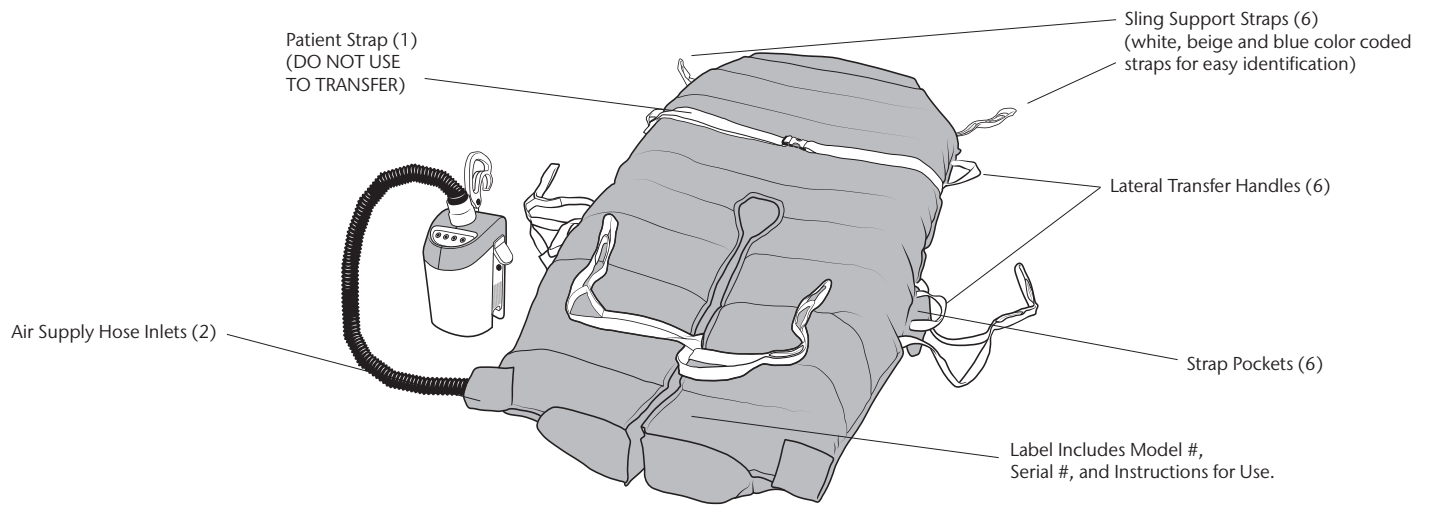

Product Specifications/Required Accessories

HOVERSLING® SPLIT-LEG

Material:	Top: Polyester knit Bottom: Nylon Twill
Construction:	Sewn
Width:	34" (86 cm)
Length:	70" (178 cm)

Model #: HMSLING-34-B* – 34" W x 70" L (10 per box)



LIMIT 700 LBS/ 318 KG

*Breathable model

REQUIRED ACCESSORY FOR USE AS A TRANSFER MATTRESS:

Model #: HTAIR1200 (North American Version) – 120V~, 60Hz, 10A
 Model #: HTAIR2300 (European Version) – 230V~, 50 Hz, 6A
 Model #: HTAIR1000 (Japanese Version) – 100V~, 50/60 Hz, 12.5A
 Model #: HTAIR2356 (Korean Version) – 230V~, 50/60 Hz, 6A
 Model #: AIR200G (800 W) – 120V~, 60Hz, 10A
 Model #: AIR400G (1100 W) – 120V~, 60Hz, 10A

REQUIRED ACCESSORY FOR USE AS A SLING:

Any patient lift with 2, 3, or 4-point loop style hanger bars intended for use with:

- Mobile hoists with sling seats
- Hoist trolleys
- Stationary hoists fixed to the wall/walls, floor and/or ceiling
- Stationary free-standing hoists

HoverSling® Split-Leg Instructions for Use as a Transfer Mattress

1. Ensure sling support straps are stowed in strap pockets and the four (4) snaps located at the center leg and foot sections are connected.
2. Patient should preferably be in a supine position.
3. Place HoverSling Split-Leg underneath patient using a log-rolling technique and secure patient strap loosely.
4. Plug the HoverTech Air Supply power cord into an electrical outlet.
5. Insert the hose nozzle into one of two hose entries at foot end of HoverSling Split-Leg and snap into place.
6. Ensure that transfer surfaces are as close as possible and lock all wheels.
7. If possible, transfer from a higher surface to a lower surface.
8. Turn on HoverTech Air Supply.
9. Push inflated HoverSling Split-Leg at an angle, either headfirst or feet-first. Once half-way across, opposite caregiver should grasp closest handles and pull to desired location.
10. Ensure patient is centered on receiving equipment prior to deflation.
11. Turn off Air Supply and employ the bed/stretcher rails. Unbuckle patient strap.

HoverSling® Split-Leg Instructions for Use as a Sling

INSTRUCTIONS FOR USE – PATIENT IN BED

Note: HoverSling Split-Leg has six (6) sling support straps that need to be connected.

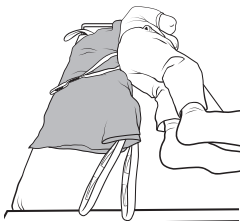

1. **Option 1** – Place the HoverSling Split-Leg underneath patient using log-rolling technique with the apex of the sling's horseshoe at the coccyx of the patient. Elevate the head of the bed.

Option 2 – Elevate the head of the bed. Lean patient forward and slide sling behind patient's back until the apex of the horseshoe reaches the coccyx of the patient. Have patient lean back to hold sling in place.



3. Release inside leg snaps. Cross inside leg support straps by taking one leg support strap and passing it through the other on the opposite side. Attach inside leg supports to hanger bar.

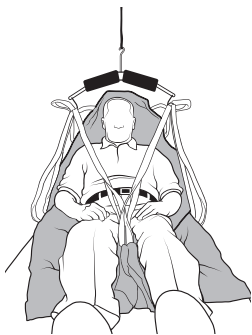

2. Attach shoulder straps to the hanger bar for the proper safety and comfort of the patient. [Color coded strap loops provide easy identification to match strap placement on the left and right side of the patient. Shorter strap loops at shoulder (blue/beige) create a more upright sitting position, while longer shoulder and leg strap loops (white) increase recline angle and reduce hip flexion].

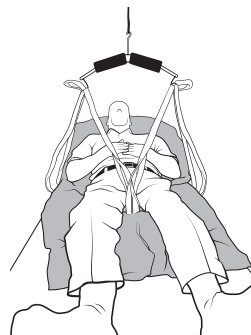

4. Attach outside leg support straps to hanger bar. Transfer patient.

NOTE: When transferring to a chair, recline the chair and elevate the footrest if possible.

INSTRUCTIONS FOR USE – BACK TO BED

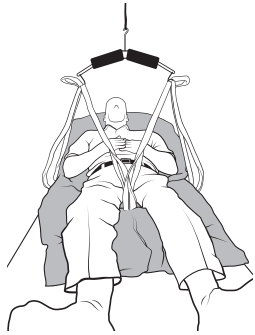

1. Position patient above center of bed.
Raise head of bed and lower patient on to bed.



2. Detach strap loops from hanger bar.

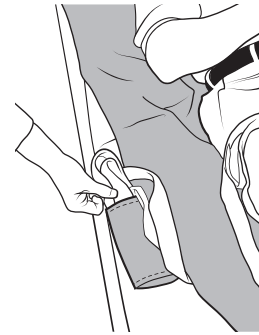

3. Place the sling support straps back into the strap pockets on the inside and outside edges of the HoverSling Split-Leg.

INSTRUCTIONS FOR USE – PATIENT IN CHAIR

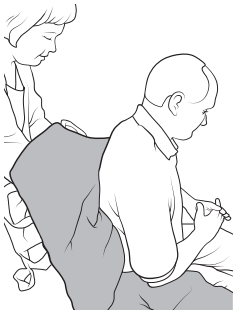

1. Release leg snaps. Lean patient forward. Place the apex of the sling's horseshoe behind the patient until you touch the seat ensuring the sling is centered on the patient's torso. Have patient lean back against the sling to hold it in place.

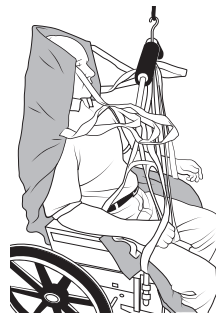

3. Attach shoulder straps to the hanger bar for the proper safety and comfort of the patient. [Color coded strap loops provide easy identification to match strap placement on the left and right side of the patient. Shorter strap loops at shoulder (blue/ beige) create a more upright sitting position, while longer shoulder and leg strap loops (white) increase recline angle and reduce hip flexion.]

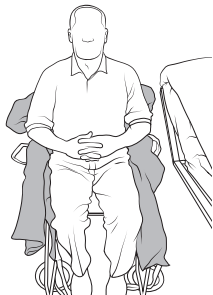

2. Place the leg sections along the side of the hips and legs, then place each leg section underneath each respective leg.

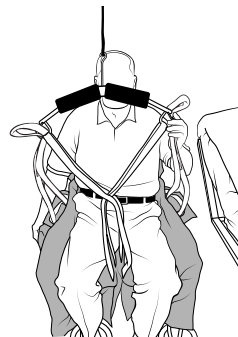

4. Cross inside leg support straps by taking one leg support strap and passing it through the other on the opposite side. Attach inside and outside leg support straps to hanger bar. Transfer Patient.

Part Identification – HoverSling® Repositioning Sheet HoverSling Repositioning Sheet with HoverCover™

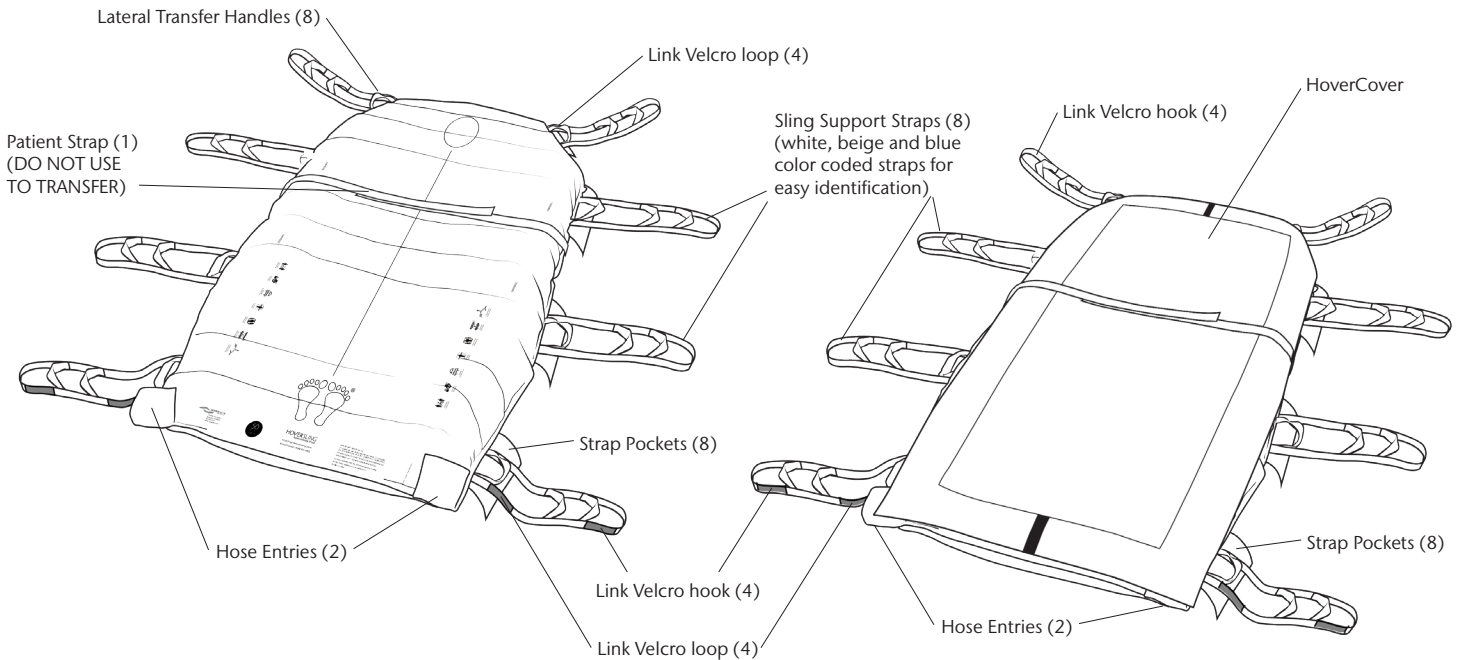

Product Specifications/Required Accessories

HOVERSLING® REPOSITIONING SHEET

Material:	Top: Polyester knit Bottom: Nylon Twill
Construction:	Sewn
Width:	39" (99 cm) 50" (127 cm)
Length:	78" (198 cm)

HoverSling Repositioning Sheet

Model #: HMSLING-39RS-B – 39" W x 78" L (5 per box)*

Model #: HMSLING-50RS-B – 50" W x 78" L (5 per box) *

Model #: HMSLING-39RS-TVA-B – 39" W x 78" L (5 per box)*

Model #: HMSLING-50RS-TVA-B – 50" W x 78" L (5 per box) *

HoverSling Repositioning Sheet with HoverCover

Model #: HMSLING-39RS-HC – 39" W x 78" L (5 per box)*

REQUIRED ACCESSORY FOR USE AS A TRANSFER MATTRESS:

Model #: HTAIR1200 (North American Version) – 120V~, 60Hz, 10A
 Model #: HTAIR2300 (European Version) – 230V~, 50 Hz, 6A
 Model #: HTAIR1000 (Japanese Version) – 100V~, 50/60 Hz, 12.5A
 Model #: HTAIR2356 (Korean Version) – 230V~, 50/60 Hz, 6A
 Model #: AIR200G (800 W) – 120V~, 60Hz, 10A
 Model #: AIR400G (1100 W) – 120V~, 60Hz, 10A

REQUIRED ACCESSORY FOR USE AS A SLING:

Any patient lift with 2, 3, or 4-point loop style hanger bars intended for use with:

- Mobile hoists
- Hoist trolleys
- Stationary hoists fixed to the wall/walls, floor and/or ceiling
- Stationary free-standing hoists



LIMIT 1000 LBS/ 454 KG



*Breathable model

Attaching HoverSling® Repositioning Sheet** Link Sling Straps

1. Thread one end of the HoverSling link sling strap through any part of bedframe (Headboard or siderails may be used*) at top of the bed.
2. Fasten the hook of the Velcro sling strap to the Velcro loop and secure.
3. Repeat the process on the opposite side of the bed.

4. Using the same method, attach the Velcro sling straps at the footend of the bed.

Note: Be sure to remove the link sling straps prior to moving patient. Store sling straps in the side pockets when not in use.

* Per your bed type and facility protocol.

HoverSling® Repositioning Sheet** Instructions for Use as a Transfer Mattress

1. Ensure sling support straps are stowed in strap pockets.
2. Patient should preferably be in a supine position.
3. Place HoverSling Repositioning Sheet underneath patient using a log-rolling technique and secure patient strap loosely.
4. Plug the HoverTech Air Supply power cord into an electrical outlet.
5. Insert the hose nozzle into one of two hose entries at foot end of HoverSling Repositioning Sheet and snap into place.
6. Ensure that transfer surfaces are as close as possible and lock all wheels.

7. If possible, transfer from a higher surface to a lower surface.
8. Turn on HoverTech Air Supply.
9. Push inflated HoverSling Repositioning Sheet at an angle, either head-first or feetfirst. Once half-way across, opposite caregiver should grasp closest handles and pull to desired location.
10. Ensure patient is centered on receiving equipment prior to deflation.
11. Turn off Air Supply and employ the bed/stretcher rails. Unbuckle patient strap.

NOTE: When using the 50" HoverSling® Repositioning Sheet, two air supplies may be used for inflation.

HoverSling® Repositioning Sheet** Instructions for Use as a Sling

INSTRUCTIONS FOR USE – PATIENT IN BED

Note: HoverSling® Repositioning Sheet has eight (8) sling support straps that need to be attached.



1. Place the HoverSling Repositioning Sheet underneath patient using log-rolling technique.

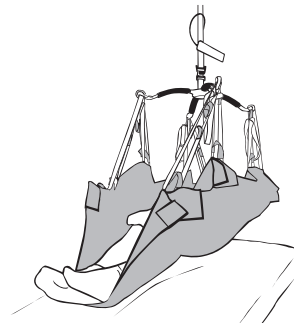

2. Attach all straps to the hanger bar for the proper safety and comfort of the patient. [Color coded strap loops provide easy identification to match strap placement on the left and right side of the patient.] Lift patient according to lift manufacturer's instructions.

STRAP USAGE						
TECHNIQUE	Seated Transfer Upright	Seated Transfer Reclined	Supine Lift	Turn	Hygiene/ Perineal Care	Prone (Use supine lift technique to move patient closer to side of bed. Then follow strap use below on one side to turn patient.)
1st Set (Head)	Green	Blue	Brown	You can use - Blue, Brown, or SKIP	SKIP	You can use - Blue, Brown, or SKIP
2nd Set (Shoulder)	Blue	Brown	Blue	Blue	Blue	Blue
3rd Set (Hip)	SKIP	SKIP	Blue	Blue	SKIP	Blue
4th Set (Foot)	White	White	Brown	You can use - Brown, White, or SKIP	SKIP	You can use - Brown, White, or SKIP

This is just a guide to using the HoverSling Repositioning Sheet. Please use clinical judgement for patient-specific needs.

** Can be utilized with or without a HoverCover

HOVERSLING® User Manual

HoverSling® Repositioning Sheet** Instructions for Use as a Sling (cont.)

INSTRUCTIONS FOR USE – BACK TO BED

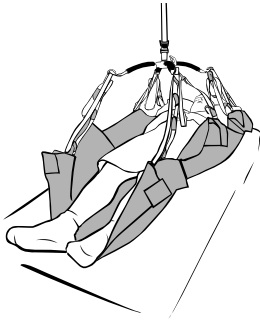

1. Position patient above center of bed.
Lower patient on the bed.

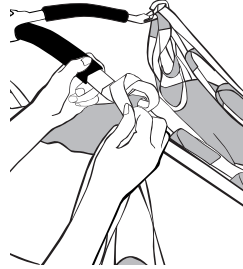

2. Detach strap loops from hanger bar.



3. Place the sling support straps back into the strap pockets on the inside and outside edges of the HoverSling Repositioning Sheet.

INSTRUCTIONS FOR USE – LATERAL TURN/PRONE

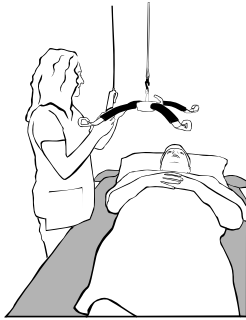

1. With patient centered on the HoverSling® Repositioning Sheet, lower hanger bar to comfortable working height.

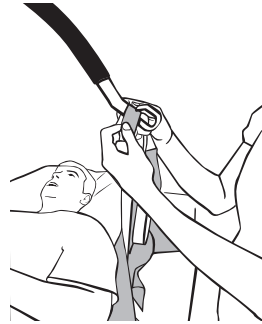

2. Raise bed rails and attach all four (4) straps on opposite side of patient turn to loops on same side of hanger bar starting at foot end.

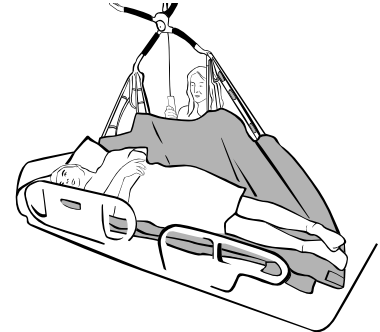

3. As lift is raised, patient will turn towards the opposite side of the bed the straps are attached to. Use wedges to keep patient in position if desired. After the task is completed, lower hanger bar and remove sling straps.

* To prone, continue the turn and adjust patient/device as necessary after the task is complete.

INSTRUCTIONS FOR USE – HYGIENE TURN

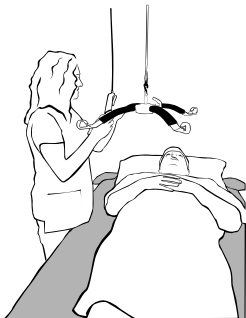

1. With patient centered on the the HoverSling Repositioning Sheet, lower hanger bar to comfortable working height.

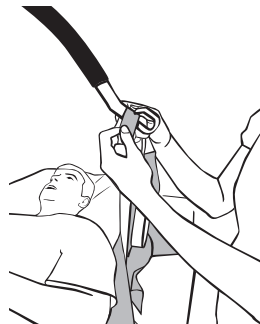

2. Raise bed rails and attach the sling strap that is closest to patient's shoulder to hanger bar.



3. As lift is raised, patient will begin to turn to the side opposite the connected strap. Leave sling in place to perform task. Once task is completed, lower hanger bar and remove sling strap.

** Can be utilized with or without a HoverCover

HoverSling® Repositioning Sheet Instructions for Use as a Sling (cont.)

INSTRUCTIONS FOR USE – SEATED TRANSFER FROM BED



1. Position the HoverSling Repositioning Sheet under the patient using the log-rolling technique. Elevate the head of the bed to prepare for the seated transfer.

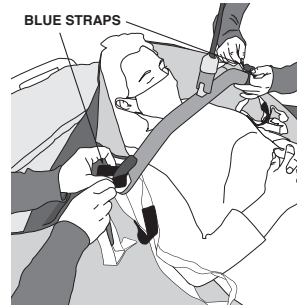

3. Attach the blue sling strap on each shoulder side (for both 39" & 50").

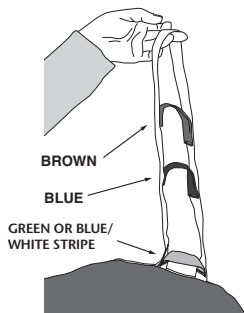

2. Attach the straps at the head of the HoverSling to the hanger bar. For a fully upright seated position – use the transfer handle (green for the 39" & blue/white stripe for the 50"). For a reclined seated position – use the 1st sling strap (blue for both the 39" & 50") to reduce the hip flexion.

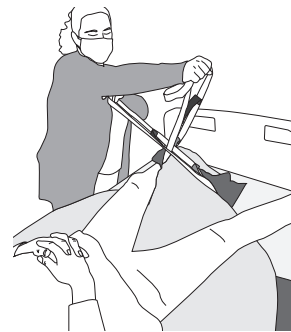

4. Fold HoverSling between patient's legs and place feet on each side of the HoverSling. Cross one foot-end sling strap through the other at the lowest loop closest to the device and attach to the hanger bar. Transfer patient.

NOTE: When possible, recline the chair and elevate the footrest. The Velcro link attachments can be utilized to secure the sling to the chair if applicable.

INSTRUCTIONS FOR USE – SEATED TRANSFER FROM CHAIR



1. Ensure the HoverSling is properly placed under the patient prior to attaching strap.

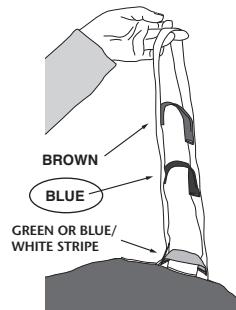

3. Attach the blue sling strap on each shoulder side (for both 39" & 50"). Make sure to allow plenty of slack in the hanger bar to attach the foot-end straps without sliding the patient off the chair.



2. Attach the straps at the head of the HoverSling to the hanger bar. For a fully upright seated position – use the transfer handle (green for the 39" & blue/white stripe for the 50"). For a reclined seated position – use the 1st sling strap (blue for both the 39" & 50") to reduce the hip flexion.



4. Fold HoverSling between patient's legs and place feet on each side of the HoverSling. Cross one foot-end sling strap through the other at the lowest loop closest to the device and attach to the hanger bar. Transfer patient.

** Can be utilized with or without a HoverCover

Part Identification – HT-Air® Air Supply

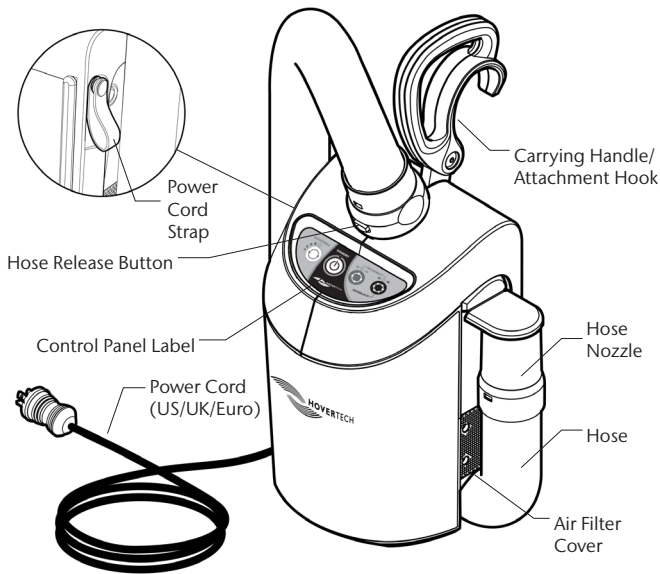

 **The HT-Air is not for use with the HJBSC-200 HoverJack Battery Cart.**

HT-Air® Keypad Functions

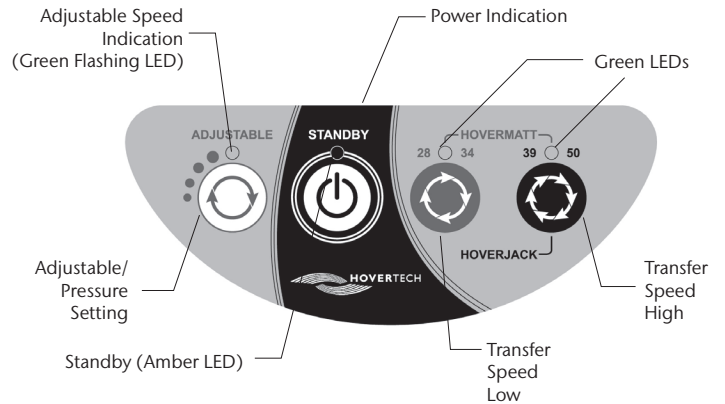

ADJUSTABLE: For use with HoverTech air-assisted positioning devices. There are four different settings. Each press of the button increases the air pressure and rate of inflation. The Green Flashing LED will indicate the inflation speed by the number of flashes (i.e. two flashes equals the second inflation speed).

All of the settings in the ADJUSTABLE range are substantially lower than the HoverMatt and HoverJack settings. The ADJUSTABLE function is not to be used for transferring.

The ADJUSTABLE setting is a safety feature that can be used to ensure the patient is centered on HoverTech air-assisted devices and to gradually accustom a patient who is timid or in pain to both the noise and functionality of the inflated devices.



STANDBY: Used to stop inflation/air flow (Amber LED indicates STANDBY mode).



HOVERMATT 28/34: For use with 28" & 34" HoverMatts and HoverSlings.



HOVERMATT 39/50 & HOVERJACK: For use with 39" & 50" HoverMatts and HoverSlings and 32" & 39" HoverJacks.

Air200G/Air400G Air Supplies

If using HoverTech's Air200G or Air400G Air Supplies, press the grey button on the top of the canister to initiate air flow. Press the button again to stop air flow.

Cleaning

To help keep the HoverSling clean, HoverTech recommends the use of the HoverCover™ or their Disposable Sheets. Whatever the patient is lying on to keep the hospital bed clean may also be placed on top of the HoverSling. The HoverSling is a single-patient use product and is not intended to be laundered.

The HoverSling has an expected life of 30 days under normal use conditions. If grossly soiled, the HoverSling should be discarded and replaced with a new one.

PREVENTIVE MAINTENANCE

The HoverSling should be checked before each use to ensure there is no damage that would cause it not to function as intended. It should have all patient straps, sling support straps and handles intact. The Do Not Launder label should be intact. There should be no tears, holes or loose threads. If such damage is found, the HoverSling should be discarded. The HoverSling is intended to be used for the duration of the patient's stay at the healthcare/nursing facility.

INFECTION CONTROL

If the HoverSling is used on an isolation patient, the hospital should employ the same protocols/procedures it utilizes to discard other contaminated single patient use devices.

AIR SUPPLY CLEANING AND MAINTENANCE

See air supply manual for reference.



When a product reaches the end of its lifetime, it should be separated by material type so that the parts can be recycled or disposed of properly in accordance with local requirements.

Transportation and Storage

This product does not require any special storage conditions.

Returns and Repairs

All products being returned to HoverTech must have a Returned Goods Authorization (RGA) number issued by the company. Please call (800) 471-2776 and ask for a member of the RGA Team who will issue you an RGA number. Any product returned without an RGA number will cause a delay in the repair time.

Returned products should be sent to:

HoverTech
Attn: RGA # _____
4482 Innovation Way
Allentown, PA 18109

For European companies, send returned products to:



Attn: RGA # _____
Kista Science Tower
SE-164 51 Kista, Sweden

For product warranties, visit our website:

<https://hovertechinternational.com/standard-product-warranty/>



HoverTech

4482 Innovation Way
Allentown, PA 18109

www.HoverTechInternational.com
Info@HoverTechInternational.com

These products comply with the standards applicable for Class 1 products in the Medical Device Regulation (EU) 2017/745 on medical devices.



Etac Supply Center AB
Långgatan 12
334 33 Anderstorp Sweden



Etac Ltd.

Unit 60, Hartlebury Trading Estate,
Hartlebury, Kidderminster,
Worcestershire, DY10 4JB
+44 121 561 2222

www.etac.com/uk



TapMed Swiss AG

Gumprechtstrasse 33
CH-6376 Emmetten
CHRN-AR-20003070

www.tapmed-swiss.ch

In case an adverse event in relation to the device, incidents should be reported to our authorized representative. Our authorized representative will forward information to the manufacturer.



4482 Innovation Way
Allentown, PA 18109

800.471.2776
Fax 610.694.9601

HoverTechInternational.com
Info@HoverTechInternational.com