



HOVERMATT®

Air Transfer System

User Manual































Visit www.HoverTechInternational.com for other languages

TABLE OF CONTENTS

Symbol Reference	2-3
Intended Use and Precautions.....	3
Instructions for Use	4-6
Part Identification - HoverMatt® Air Transfer Mattress ..	4-6
Using the HoverMatt® Air Transfer System in the Operating Room	7
Part Identification - HT-Air® Air Supply.....	8
HT-Air® Keypad Functions	8
Air200G/Air400G Air Supplies.....	8
Product Specifications/Required Accessories.....	9
Cleaning and Preventive Maintenance	10
Returns and Repairs.....	11

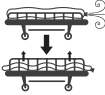
Symbol Reference

	CE MARKING OF CONFORMITY		LATEX FREE
	UK MARKING OF CONFORMITY		LOT NUMBER
	AUTHORIZED REPRESENTATIVE		MANUFACTURER
	UK RESPONSIBLE PERSON		DATE OF MANUFACTURE
	SWITZERLAND AUTHORIZED REPRESENTATIVE		MEDICAL DEVICE
	CAUTION / WARNING		MR CONDITIONAL
	IMPORTER		MR UNSAFE
	DISPOSAL		SINGLE PATIENT - MULTIPLE USE
	OPERATING INSTRUCTIONS		DO NOT LAUNDRY
	MANUAL CLEANING		UNIQUE DEVICE IDENTIFIER
	LOCK ALL WHEELS		PATIENT WEIGHT LIMIT
	ENSURE PATIENT IS FLAT		USE TWO CAREGIVERS
	CENTER PATIENT		USE THREE CAREGIVERS
	ATTACH LINK STRAP		STAY CLOSE APPROACH
	FASTEN PATIENT STRAP (BUCKLE)		DEFLATE, RAISE RAILS
	FASTEN PATIENT STRAP (VELCRO®)		LOOP STYLE HANGER BAR

HOVERMATT® User Manual

Symbol Reference



MODEL NUMBER



FOOT END



SERIAL NUMBER



KEEP DRY / PROTECTED FROM MOISTURE



DECLARATION OF CONFORMITY

This product conforms to the requirements of Medical Devices Regulation (2017/745).

Intended Use and Precautions

INTENDED USE

The HoverMatt® Air Transfer System is used to assist caregivers with patient transfers, positioning (including boosting and turning), and proning. The HoverTech Air Supply inflates the HoverMatt to cushion and cradle the patient, while air simultaneously escapes from the holes on the underside, reducing the force needed to move the patient by 80-90%.

INDICATIONS

- Patients unable to assist in their own lateral transfer.
- Patients whose weight or girth poses a potential health risk for the caregivers responsible for repositioning or laterally transferring said patients.

CONTRAINDICATIONS

- Patients who are experiencing thoracic, cervical or lumbar fractures that are deemed unstable should not use the HoverMatt unless a clinical decision has been made by your facility.

INTENDED CARE SETTINGS

- Hospitals, long term or extended care facilities.

PRECAUTIONS – AIR SUPPLY

- Not for use in the presence of flammable anesthetics or in a hyperbaric chamber or oxygen tent.
- Route the power cord in a manner to ensure freedom from hazard.
- Avoid blocking the air intakes of the air supply.
- When using the HoverMatt in the MRI environment, a 25 ft. specialty MRI hose is required (available for purchase).



Avoid electric shock. Do not open air supply.



Reference product specific user manuals for operating instructions.

PRECAUTIONS – HOVERMATT

- Caregivers must verify that all brakes have been engaged prior to transfer.
- Use a minimum of two caregivers during air-assisted lateral patient transfers.
- For in-bed air-assisted positioning tasks, more than one caregiver may be required.
- For air-assisted proning, see training video at www.HoverTechInternational.com.
- Never leave patient unattended on an inflated device.
- Use this product only for its intended purpose as described in this manual.
- Only use attachments and/or accessories that are authorized by HoverTech.
- When transferring to and from a low air loss bed, set the bed mattress air flow to the highest level for a firm transfer surface.
- Never attempt to move a patient on an uninflated HoverMatt.



Side rails must be raised with one caregiver.



In the OR – To prevent patient from slipping, always deflate the HoverMatt and secure the patient and HoverMatt to the OR table prior to moving the table into an angled position.

PRECAUTIONS – MRI

- The HoverMatt is MR conditional by rationale. The device is made from all non-ferrous materials. As a result, MR safety testing was not performed. Based on rationale, the HoverMatt is electronically non-conductive and non-magnetic.
- When using a HoverMatt in an MRI environment a 25 ft. specialty MRI hose is required, thus making these products MRI conditional. The HoverTech air supply and regular hose are conductive and magnetic and are MR Unsafe.

Instructions for Use – HoverMatt®* and HoverMatt® SPU

1. Patient should preferably be in a supine position.
2. Place HoverMatt underneath patient using a log-rolling technique and secure patient straps loosely.
3. Plug the HoverTech Air Supply power cord into an electrical outlet.
4. Insert the hose nozzle into either of two intake valves at foot end of HoverMatt - snap into place and close flap.
5. Ensure that transfer surfaces are as close as possible and lock all wheels.
6. If possible, transfer from a higher surface to a lower surface.
7. Turn on HoverTech Air Supply.
8. Push HoverMatt at an angle, either headfirst or feetfirst. Once half way across, opposite caregiver should grasp closest handles and pull to desired location.
9. Ensure patient is centered on receiving equipment prior to deflation.
10. Turn off air supply and raise the bed/stretcher rails. Unbuckle patient straps.

NOTE: When using the HoverMatt with patients of size or when more lift is needed, two air supplies may be used for inflation.

*Reusable.

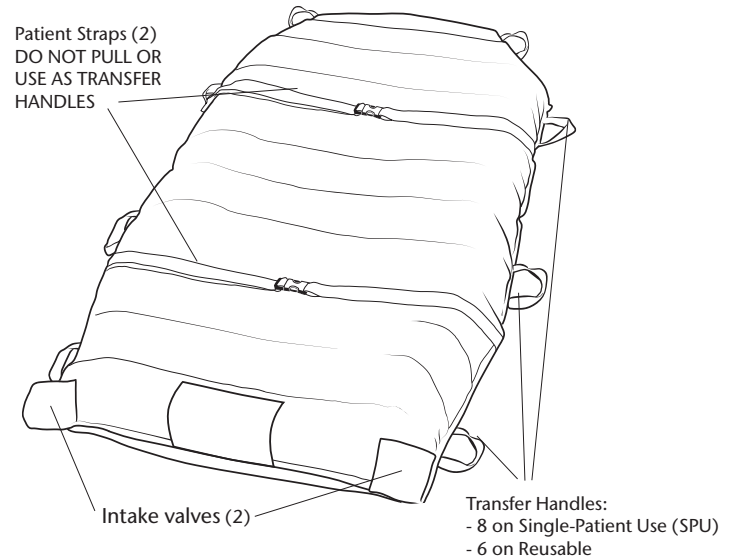

Instructions for Use – HoverMatt® SPU Link

ATTACHING TO BEDFRAME

1. Remove Link straps from pockets and loosely attach to solid points on the bed frame to allow the SPU Link to move with the patient.
2. Before lateral transfers and positioning, disconnect Link straps from bed frame and stow in corresponding storage pockets.

LATERAL TRANSFER

1. Patient should preferably be in a supine position.
2. Place HoverMatt SPU Link underneath patient using a log-rolling technique and secure patient straps loosely.
3. Plug the HoverTech Air Supply power cord into an electrical outlet.
4. Insert the hose nozzle into either of two intake valves at foot end of HoverMatt SPU Link and snap into place and close flap.
5. Ensure that transfer surfaces are as close as possible and lock all wheels.
6. If possible, transfer from a higher surface to a lower surface.
7. Turn on HoverTech Air Supply.
8. Push HoverMatt SPU Link at an angle, either headfirst or feetfirst. Once half way across, opposite caregiver should grasp closest handles and pull to desired location.

9. Ensure patient is centered on receiving equipment prior to deflation.
10. Turn off air supply and raise the bed/stretcher rails. Unfasten patient straps.
11. Remove Link straps from pockets and loosely attach to solid points on bed frame.

NOTE: When using the HoverMatt with patients of size or when more lift is needed, two air supplies may be used for inflation.

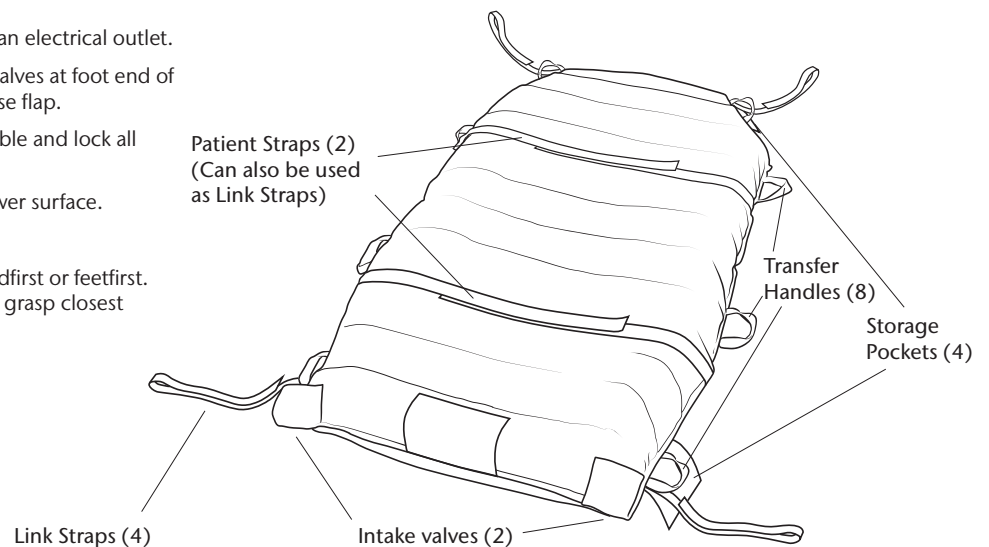

Instructions for Use – HoverMatt® SPU Split-Leg

LITHOTOMY POSITION

1. Separate the legs into two individual sections by disconnecting the snaps.
2. Position each section on the table with the patient's legs.

LATERAL TRANSFER

1. Ensure all snaps located at the center leg and foot sections are connected.
2. Patient should preferably be in supine position.
3. Place the HoverMatt SPU Split-Leg underneath the patient using a log-rolling technique and secure patient strap loosely.
4. Plug HoverTech Air Supply power cord into an electrical outlet.
5. Insert hose nozzle into either of the two intake valves located at the footend of the HoverMatt SPU Split-Leg, and snap into place.
6. Ensure that transfer surfaces are as close as possible and lock all wheels.
7. If possible, transfer from a higher surface to a lower surface.
8. Turn on HoverTech Air Supply.
9. Push HoverMatt SPU Split-Leg at an angle, either headfirst or feetfirst. Once half way across, opposite caregiver should grasp closest handles and pull to desired location.
10. Ensure patient is centered on receiving equipment prior to deflation.
11. Turn off HoverTech Air Supply and raise bed/stretcher rails. Unbuckle patient strap.
12. When the HoverMatt SPU Split-Leg is deflated, position each leg section as appropriate.

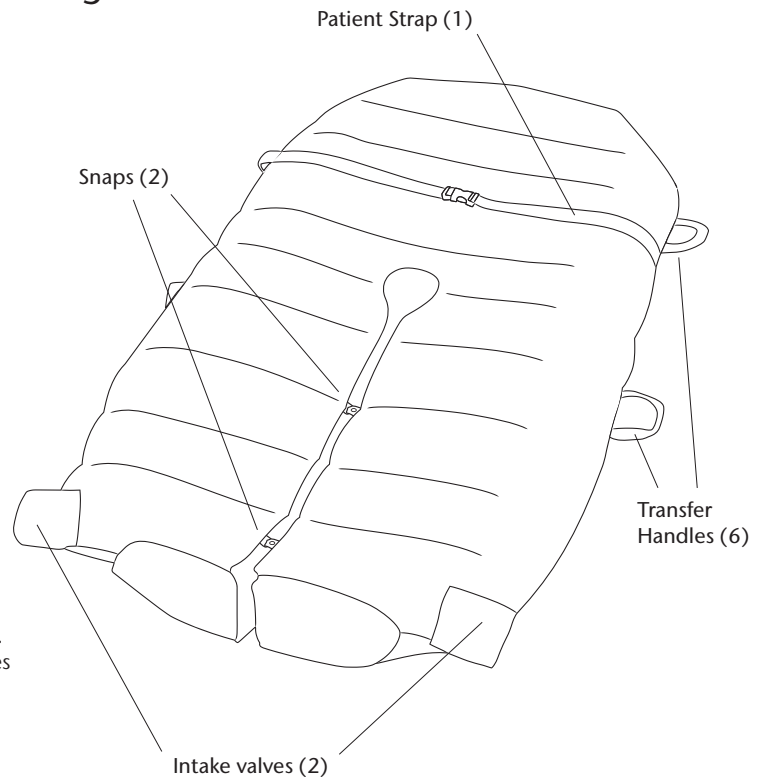

Instructions for Use – HoverMatt® Half-Matt* and HoverMatt® SPU Half-Matt

1. Patient should preferably be in a supine position.
2. Place HoverMatt Half-Matt underneath patient using a log-rolling technique and secure patient strap loosely.
3. Plug the HoverTech Air Supply power cord into an electrical outlet.
4. Insert hose nozzle into either of two intake valves at foot end of HoverMatt and snap into place.
5. Ensure that transfer surfaces are as close as possible and lock all wheels.
6. If possible, transfer from a higher surface to a lower surface.
7. Turn on HoverTech Air Supply.
8. Push HoverMatt Half-Matt at an angle, either headfirst or feetfirst. Once half way across, opposite caregiver should grasp closest handles and pull to desired location. Ensure caregiver at footend guides patient's feet during the transfer.
9. Ensure patient is centered on receiving equipment prior to deflation.
10. Turn off HoverTech Air Supply and raise the bed/stretcher rails. Unbuckle patient strap.

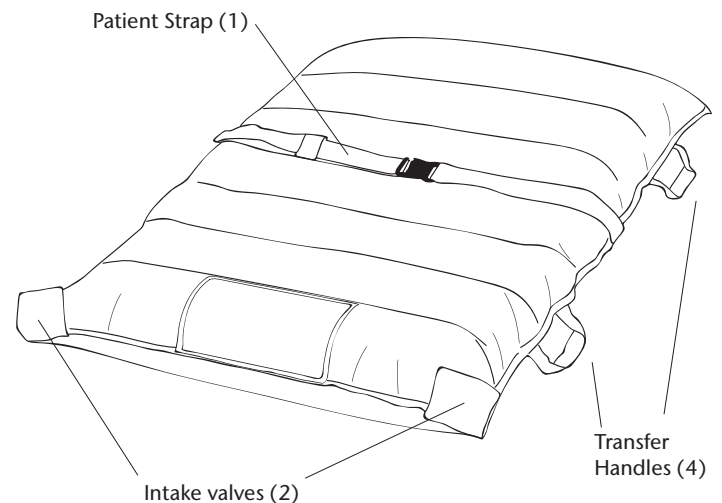

PRECAUTION: USE A MINIMUM OF THREE CAREGIVERS DURING AIR-ASSISTED LATERAL PATIENT TRANSFERS WHEN USING THE HOVERMATT HALF-MATT AND HOVERMATT SPU HALF-MATT.

*Reusable.

Instructions for Use – HoverMatt® SPU with HoverCover™

1. Patient should preferably be in a supine position.
2. Place HoverMatt SPU with HoverCover underneath patient using a log-rolling technique and secure patient straps loosely.
3. Plug the HoverTech Air Supply power cord into an electrical outlet.
4. Insert the hose nozzle into either of two intake valves at foot end of HoverMatt and snap into place.
5. Ensure that transfer surfaces are as close as possible and lock all wheels.
6. If possible, transfer from a higher surface to a lower surface.
7. Turn on HoverTech Air Supply.
8. Push HoverMatt at an angle, either headfirst or feetfirst. Once half way across, opposite caregiver should grasp closest handles and pull to desired location.
9. Ensure patient is centered on receiving equipment prior to deflation.
10. Turn off air supply and raise the bed/stretcher rails. Unbuckle patient straps.

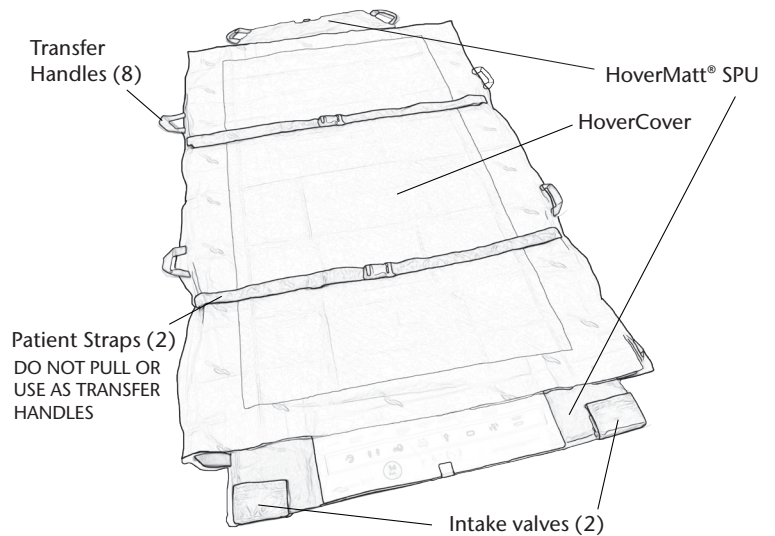

NOTE: When using the HoverMatt with patients of size or when more lift is needed, two air supplies may be used for inflation.

Instructions for Use – HoverMatt® SPU Link with HoverCover

ATTACHING TO BEDFRAME

1. Remove Link straps from pockets and loosely attach to solid points on the bed frame to allow the SPU Link with HoverCover to move with the patient.
2. Before lateral transfers and positioning, disconnect Link straps from bed frame and stow in corresponding storage pockets.

LATERAL TRANSFER

1. Patient should preferably be in a supine position.
2. Place HoverMatt SPU Link with HoverCover underneath patient using a log-rolling technique and secure patient straps loosely.
3. Plug the HoverTech Air Supply power cord into an electrical outlet.
4. Insert the hose nozzle into either of two intake valves at foot end of HoverMatt SPU Link with HoverCover, snap into place and close flap.
5. Ensure that transfer surfaces are as close as possible and lock all wheels.
6. If possible, transfer from a higher surface to a lower surface.
7. Turn on HoverTech Air Supply.
8. Push HoverMatt SPU Link with HoverCover at an angle, either headfirst or feetfirst. Once half way across, opposite caregiver should grasp closest handles and pull to desired location.
9. Ensure patient is centered on receiving equipment prior to deflation.
10. Turn off air supply and raise the bed/stretcher rails. Unfasten patient straps.
11. Remove Link straps from pockets and loosely attach to solid points on bed frame.

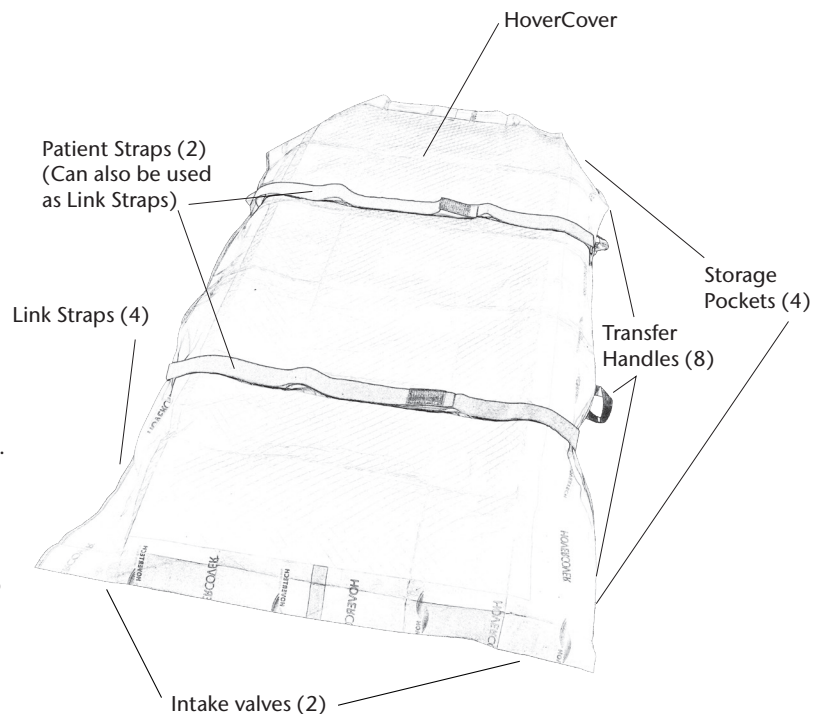

NOTE: When using the HoverMatt with patients of size or when more lift is needed, two air supplies may be used for inflation.

Using the HoverMatt® Air Transfer System in the Operating Room

The HoverMatt may be used to transfer, position, and reposition patients to and from the operating room. A patient may ambulate onto a pre-positioned HoverMatt on an operating room (OR) table, or a HoverMatt can be deployed in a typical fashion for patients unable to ambulate and / or who are dependent. The latter would typically occur in a pre-operative holding area where a transfer would happen from a stretcher/bed to an OR table; this may also occur with an inpatient already on top of a HoverMatt.

Precautions for US in the Operating Room (OR):

1. Follow steps outlined in this manual (pages 4-7) for lateral patient transfers.
2. Ensure OR Table is locked before initiating a lateral transfer.
3. Ensure the edges of HoverMatt are tucked under the OR Table mattress after transfer.

The HoverMatt® T-Burg™ is intended for all surgical procedures where a patient may be placed in Trendelenburg (or Reverse Trendelenburg) up to 40 degrees, including with use of robotics. Patient transfer / repositioning / boosting can be facilitated before and / or after the procedure where the patient's weight might place staff at risk for injury. The HoverMatt T-Burg is designed to securely hold a patient in varying degrees of Trendelenburg, up to 40 degrees. The HoverMatt T-Burg has a 400lb weight limit.

For more information, see User Manual for the HoverMatt T-Burg.



In the OR – To prevent patient from slipping, always deflate the HoverMatt and secure the patient and HoverMatt to the OR table prior to moving the table into an angled position.

Part Identification – HT-Air® Air Supply

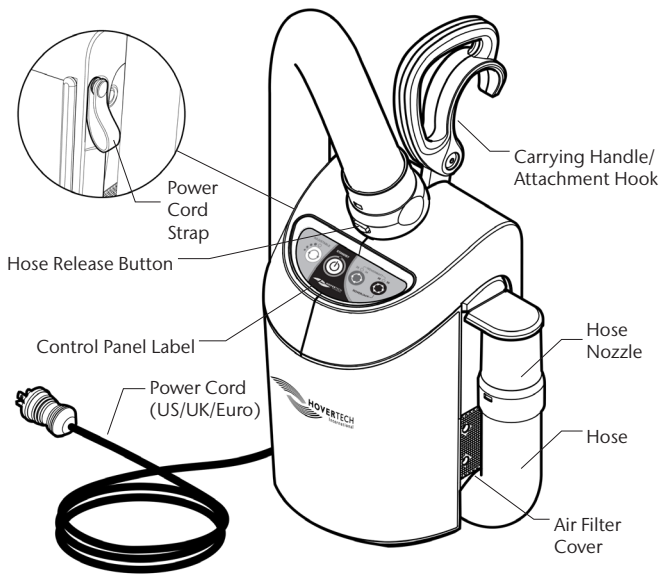

HT-Air® Keypad Functions

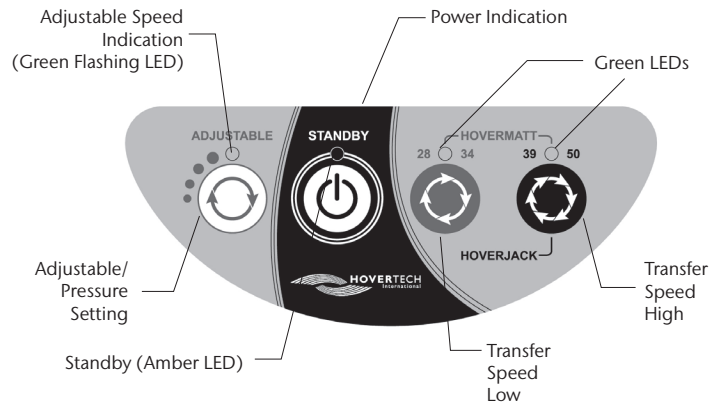

ADJUSTABLE: For use with HoverTech air-assisted positioning devices. There are four different settings. Each press of the button increases the air pressure and rate of inflation. The Green Flashing LED will indicate the inflation speed by the number of flashes (i.e. two flashes equals the second inflation speed).

All of the settings in the ADJUSTABLE range are substantially lower than the HoverMatt and HoverJack settings. The ADJUSTABLE function is not to be used for transferring.

The ADJUSTABLE setting is a safety feature that can be used to ensure the patient is centered on HoverTech air-assisted devices and to gradually accustom a patient who is timid or in pain to both the noise and functionality of the inflated devices.



STANDBY: Used to stop inflation/air flow (Amber LED indicates STANDBY mode).



HOVERMATT 28/34: For use with 28" & 34" HoverMatts and HoverSlings.



HOVERMATT 39/50 & HOVERJACK: For use with 39" & 50" HoverMatts and HoverSlings and 32" & 39" HoverJacks.

Air200G/Air400G Air Supplies

If using HoverTech's Air200G or Air400G Air Supplies, press the grey button on the top of the canister to initiate air flow. Press the button again to stop air flow.

Product Specifications/Required Accessories

HOVERMATT® AIR TRANSFER MATTRESS (REUSABLE)

Material:	Heat-Sealed: Nylon twill Double-Coated: Nylon twill with polyurethane coating on patient side
Construction:	RF-Welded
Width:	28" (71 cm), 34" (86 cm), 39" (99 cm), 50" (127 cm)
Length:	78" (198 cm) Half-Matt: 45" (114 cm)

Heat-Sealed Construction

Model #: HM28HS – 28" W x 78" L
Model #: HM34HS – 34" W x 78" L
Model #: HM39HS – 39" W x 78" L
Model #: HM50HS – 50" W x 78" L

Double-Coated Construction

Model #: HM28DC – 28" W x 78" L
Model #: HM34DC – 34" W x 78" L
Model #: HM39DC – 39" W x 78" L
Model #: HM50DC – 50" W x 78" L



WEIGHT LIMIT 1200 LBS/ 544KG

HoverMatt Half-Matt

Model #: HM-Mini34HS – 34" W x 45" L

Double-Coated Construction

Model #: HM-Mini34DC – 34" W x 45" L



WEIGHT LIMIT 600 LBS/ 272 KG

REQUIRED ACCESSORY:

Model #: HTAIR1200 (North American Version) – 120V~, 60Hz, 10A
Model #: HTAIR2300 (European Version) – 230V~, 50 Hz, 6A
Model #: HTAIR1000 (Japanese Version) – 100V~, 50/60 Hz, 12.5A
Model #: HTAIR2356 (Korean Version) – 230V~, 50/60 Hz, 6A
Model #: AIR200G (800 W) – 120V~, 60Hz, 10A
Model #: AIR400G (1100 W) – 120V~, 60Hz, 10A

HOVERMATT® SINGLE-PATIENT USE AIR TRANSFER MATTRESS

Material:	Top: Non-woven polypropylene fiber Bottom: Nylon twill
Construction:	Sewn
Width:	34" (86 cm), 39" (99 cm), 50" (127 cm)
Length:	Varies by product Half-Matt: 45" (114 cm)

HoverMatt SPU

Model #: HM34SPU-B – 34" W x 78" L (10 per box)*
Model #: HM39SPU-B – 39" W x 78" L (10 per box)*
Model #: HM50SPU-B – 50" W x 78" L (5 per box)*
Model #: HM50SPU-B-1Matt – 50" W x 78" L (1 Unit)*

HoverMatt SPU with HoverCover

Model #: HMHC-34 – 34" W x 78" L (10 per box)*
Model #: HMHC-39 – 39" W x 78" L (10 per box)*

HoverMatt SPU Split-Leg Matt

Model #: HM34SPU-SPLIT-B – 34" W x 70" L (10 per box)*

HoverMatt SPU Link

Model #: HM34SPU-LNK-B – 34" W x 78" L (10 per box)*
Model #: HM39SPU-LNK-B – 39" W x 78" L (10 per box)*
Model #: HM50SPU-LNK-B – 50" W x 78" L (5 per box)*
Model #: HM50SPU-LNK-B-1Matt – 50" W x 78" L (1 Unit)*

HoverMatt SPU Link with HoverCover

Model #: HM39SPU-LNK-HC – 39" W x 78" L (10 per box)*
Model #: HM50SPU-LNK-HC – 50" W x 78" L (5 per box)*



WEIGHT LIMIT 1200 LBS/ 544 KG

HoverMatt SPU Half-Matt

Model #: HM34SPU-HLF-B – 34" W x 45" L (10 per box)*
Model #: HM39SPU-HLF-B – 39" W x 45" L (10 per box)*



WEIGHT LIMIT 600 LBS/ 272 KG

*Breathable model

REQUIRED ACCESSORY:

Model #: HTAIR1200 (North American Version) – 120V~, 60Hz, 10A
Model #: HTAIR2300 (European Version) – 230V~, 50 Hz, 6A
Model #: HTAIR1000 (Japanese Version) – 100V~, 50/60 Hz, 12.5A
Model #: HTAIR2356 (Korean Version) – 230V~, 50/60 Hz, 6A
Model #: AIR200G (800 W) – 120V~, 60Hz, 10A
Model #: AIR400G (1100 W) – 120V~, 60Hz, 10A

Cleaning and Preventive Maintenance

HOVERMATT CLEANING AND MAINTENANCE (REUSABLE ONLY)

In between patient uses, the HoverMatt should be wiped down with a cleaning solution used by your hospital for medical equipment disinfection. A 10:1 bleach solution (10 parts water: one part bleach) or disinfecting wipes can also be used. It is important to follow the cleaning solution manufacturer's instructions for use, including dwell time and saturation.

NOTE: Cleaning with bleach solution may discolor fabric.

If a reusable HoverMatt becomes badly soiled, it should be laundered in a washing machine with a 160° F (71° C) maximum water temperature. A 10:1 bleach solution may be used (10 parts water: one part bleach) during the wash cycle.

The HoverMatt should be air dried if possible. Air drying can be expedited by using the air supply to circulate air through the inside of the HoverMatt. If using a dryer, the temperature setting should be set on the coolest setting. Drying temperature should never exceed 115° F (46° C). The backing of the nylon is polyurethane and will begin to deteriorate after repeated high temperature drying.



The Double-Coated HoverMatt should not be put in the dryer.

To help keep the HoverMatt clean, HoverTech recommends the use of the HoverCover™ Disposable Absorbent Cover or their Disposable Sheets. Whatever the patient is lying on to keep the hospital bed clean may also be placed on top of the HoverMatt.



The Single-Patient Use HoverMatt is not intended to be laundered.

AIR SUPPLY CLEANING AND MAINTENANCE

See air supply manual for reference.

NOTE: CHECK YOUR LOCAL/STATE/FEDERAL/INTERNATIONAL GUIDELINES BEFORE DISPOSAL.

PREVENTIVE MAINTENANCE

Prior to use, a visual inspection should be performed on the HoverMatt to ensure that there is no visible damage that would render the HoverMatt unusable. The HoverMatt should have all of its patient straps and handles (reference the manual for all appropriate parts). There should be no tears or holes that would prevent the HoverMatt from inflating. If any damage is found that would cause the system not to function as intended, the HoverMatt should be removed from use and returned to HoverTech for repair (Single-Patient Use HoverMatts should be discarded).

INFECTION CONTROL

HoverTech offers superior infection control with our heat-sealed reusable HoverMatt. This unique construction eliminates the needle holes of a sewn mattress which can be potential bacterial entry ways. Additionally, the heat-sealed, Double-Coated HoverMatt offers a stain and fluid proof surface for easy cleaning. The Single-Patient Use HoverMatt is also available to eliminate the possibility of cross-contamination and the need for laundering.

If the HoverMatt is used for an isolation patient, the hospital should employ the same protocols/procedures it utilizes for the bed mattress and/or for linens in that patient room.



When a product reaches the end of its lifetime, it should be separated by material type so that the parts can be recycled or disposed of properly in accordance with local requirements.

Transportation and Storage



Keep dry / protected from moisture.

Returns and Repairs

All products being returned to HoverTech must have a Returned Goods Authorization (RGA) number issued by the company. Please call (800) 471-2776 and ask for a member of the RGA Team who will issue you an RGA number. Any product returned without an RGA number will cause a delay in the repair time.

Returned products should be sent to:

HoverTech
Attn: RGA # _____
4482 Innovation Way
Allentown, PA 18109

For European companies, send returned products to:



Attn: RGA # _____
Kista Science Tower
SE-164 51 Kista, Sweden

For product warranties, visit our website:

<https://hovertechinternational.com/standard-product-warranty/>



HoverTech

4482 Innovation Way
Allentown, PA 18109

www.HoverTechInternational.com
Info@HoverTechInternational.com

These products comply with the standards applicable for Class 1 products in the Medical Device Regulation (EU) 2017/745 on medical devices.



Etac Supply Center AB
Långgatan 12
334 33 Anderstorp Sweden



Etac Ltd.

Unit 60, Hartlebury Trading Estate,
Hartlebury, Kidderminster,
Worcestershire, DY10 4JB
+44 121 561 2222

www.etac.com/uk



TapMed Swiss AG

Gumprechtstrasse 33
CH-6376 Emmetten
CHRN-AR-20003070

www.tapmed-swiss.ch

In case an adverse event in relation to the device, incidents should be reported to our authorized representative. Our authorized representative will forward information to the manufacturer.



4482 Innovation Way
Allentown, PA 18109

800.471.2776
Fax 610.694.9601

HoverTechInternational.com
Info@HoverTechInternational.com