



HOVERJACK® Evacuation

User Manual























Visit www.HoverMatt.com for other languages

TABLE OF CONTENTS

Symbol Reference	2
Intended Use and Precautions.....	3
Part Identification – Evacuation HoverJack®	4
Instructions for Use	5
Product Specifications/Required Accessories.....	6
Part Identification – HT-Air® Air Supply.....	7
HT-Air® Keypad Functions	7
Air200G/Air400G Air Supplies.....	7
Cleaning & Preventive Maintenance	8
Returns and Repairs.....	9

Symbol Reference

	CE MARKING OF CONFORMITY		KEEP DRY
	UK MARKING OF CONFORMITY		LATEX FREE
	AUTHORIZED REPRESENTATIVE		MANUFACTURER
	UK RESPONSIBLE PERSON		DATE OF MANUFACTURE
	SWITZERLAND AUTHORIZED REPRESENTATIVE		MEDICAL DEVICE
	CAUTION / WARNING		MODEL NUMBER
	MANUAL CLEANING		SERIAL NUMBER
	IMPORTER		DO NOT LAUNDRER
	DISPOSAL		UNIQUE DEVICE IDENTIFIER
	FASTEN PATIENT SAFETY STRAP		PATIENT WEIGHT LIMIT
	FOOT END		

HOVERJACK®

Evacuation User Manual



DECLARATION OF CONFORMITY

This product conforms to the requirements of Medical Devices Regulation (2017/745).

Intended Use and Precautions

INTENDED USE

The Evacuation HoverJack® Device is used to transport patients up or down stairs in the event of an emergency. The Evacuation HoverJack can also be used to lift a patient in supine position from the floor to bed or stretcher height, utilizing the HoverTech Air Supply to inflate each of the four chambers.

INDICATIONS

- Patients unable to assist in their own vertical lift or evacuation, such as after a fall or in an emergency situation.
- Patients whose weight or girth poses a potential health risk for the caregivers responsible for lifting or moving said patients.
- CPR compatible when fully inflated.

CONTRAINDICATIONS

- Patients who are experiencing thoracic, cervical or lumbar fractures that are deemed unstable should not use the Evacuation HoverJack unless a clinical decision has been made by your facility.

INTENDED CARE SETTINGS

- Hospitals, long term or extended care facilities.

PRECAUTIONS

- Make sure patient safety straps are secured before moving. Do not secure before inflation.
- Move the Evacuation HoverJack using the transport straps and/or the transport handles located along the top perimeter.
- Never use patient safety straps to pull the Evacuation HoverJack, as they may tear.
- When moving a patient on the inflated Evacuation HoverJack, use caution and move slowly.

- Additional caregivers are recommended when moving or evacuating a patient over 350 lbs./159 kg.
- Never attempt to move a patient on an uninflated Evacuation HoverJack.
- Never leave a patient unattended on an inflated device.
- Use this product only for its intended purpose as described in this manual.
- Only use attachments and/or accessories that are authorized by HoverTech International.

WARNING/CAUTION

- Always use a minimum of two caregivers while inflating/transporting the Evacuation HoverJack.
- A minimum of three caregivers is required for stairwell evacuation.
- One caregiver should remain on the side of the patient during inflation with the second caregiver managing inflation. If available, a third caregiver should attend to the other side of the patient.
- Reference product-specific user manuals for additional operating instructions.

PRECAUTIONS

– HOVERTECH INTERNATIONAL AIR SUPPLY

- Not for use in the presence of flammable anesthetics or in a hyperbaric chamber or oxygen tent.
- Route the power cord in a manner to ensure freedom from hazard.
- Avoid blocking the air intakes of the HoverTech International Air Supply.



Avoid electric shock. Do not open HoverTech International Air Supply.

Note: Two versions of Evacuation HoverJack® Air Patient Lift



SEPARATE INFLATE/DEFLATE VALVES.

[Mfg before 6/2023]



UNIVERSAL VALVES.

[Mfg after 6/2023]

HOVERJACK®

Evacuation User Manual

Part Identification - Evacuation HoverJack® [Manufactured before 6/2023]

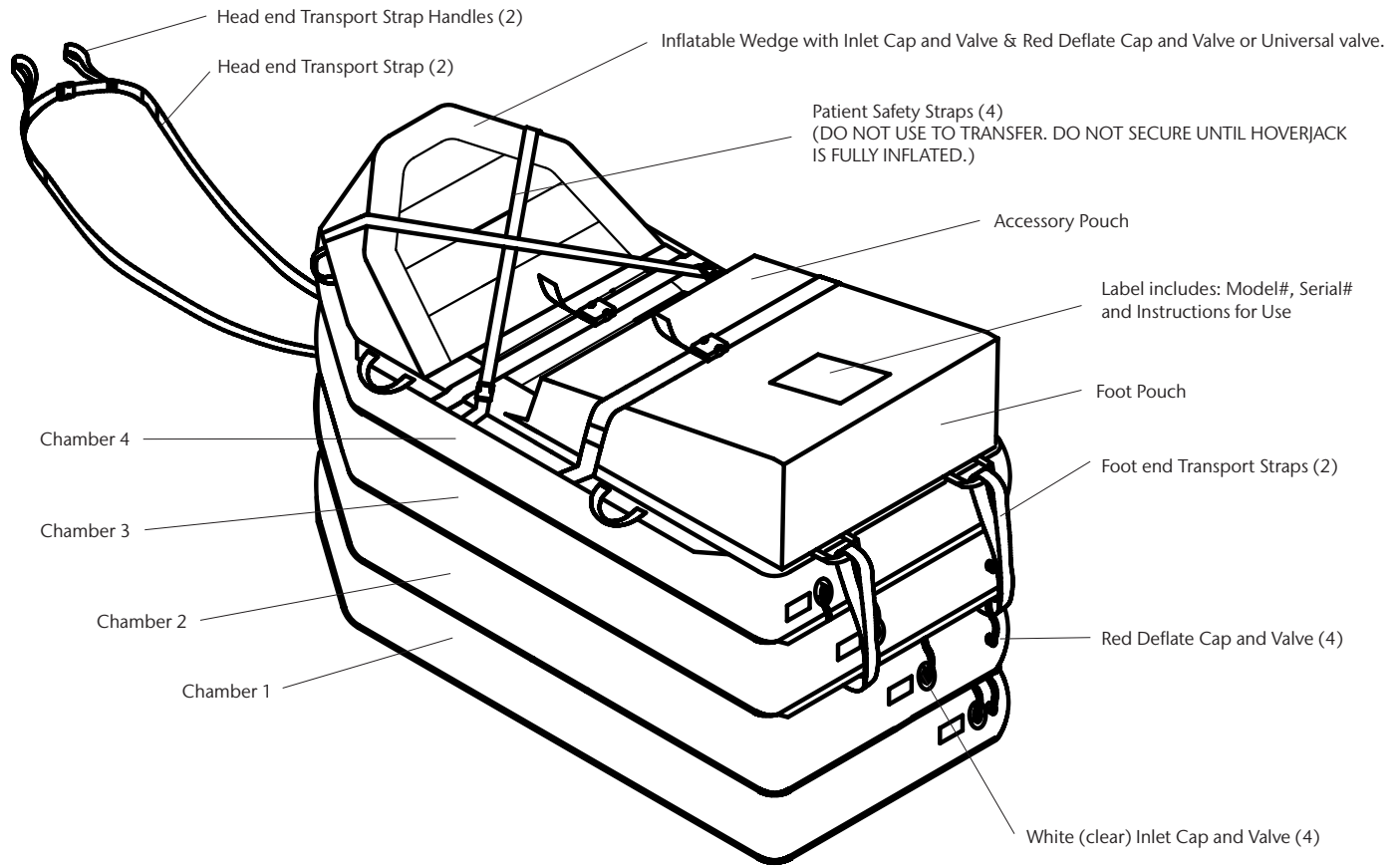

Evacuation HoverJack® [Manufactured after 6/2023]

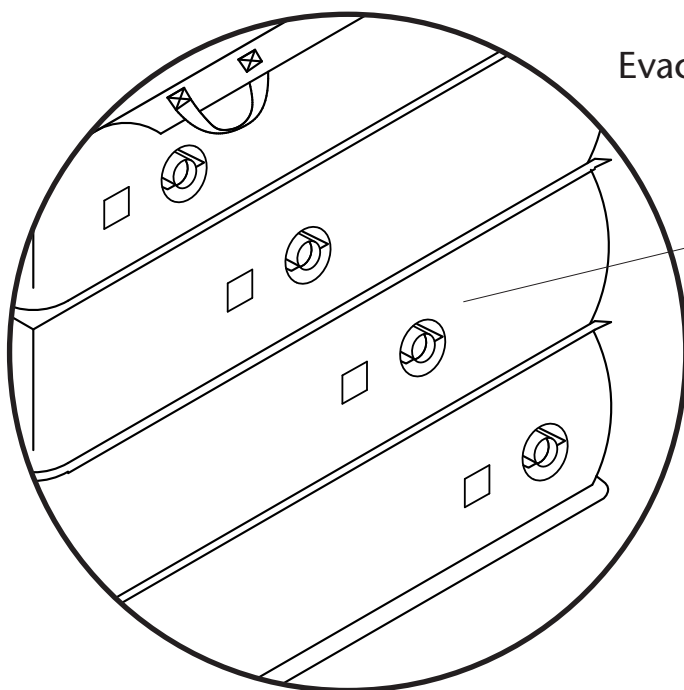

Universal Valve (4 Total)
Close before inflating.
Open to deflate.
Depress center button for slower deflation.

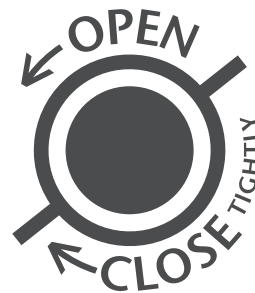

HOVERJACK®

Evacuation User Manual

Evacuation HoverJack® Instructions for Use as an Air Patient Lift

1. Place Evacuation HoverJack® on the floor next to the patient, making sure the chamber with Valve #4 is on the top and the chamber with Valve #1 is against the floor.
2. Make certain that all four red-capped deflation valves are capped tightly or Universal Valves are closed BEFORE INFLATING.
3. Log roll patient onto the deflated Evacuation HoverJack, and position patient with feet at the valve end where indicated. Alternatively, the patient can be placed on top of the Evacuation HoverJack using the HoverMatt® Air Transfer System (see HoverMatt manual for instructions). If the HoverMatt is used, make certain that the HoverMatt and patient are properly centered on the Evacuation HoverJack. Always deflate the HoverMatt prior to inflating the Evacuation HoverJack.
4. Always use a minimum of two caregivers while using the Evacuation HoverJack during inflation/transport.
5. One caregiver should remain on the side of the patient during inflation with the second caregiver managing inflation. If available, a third caregiver should attend to the other side of the patient.
6. Plug the HoverTech International Air Supply power cord into an electrical outlet.
7. Caregiver at foot end turns on HoverTech International Air Supply to initiate air flow.
8. To begin inflation hold hose against valve #1 of Evacuation HoverJack (valve closest to the floor).
9. When fully inflated, remove hose. Chamber remains inflated.
10. Secure patient safety straps.
11. Using the same process: move to valve #2, valve #3 and valve #4 in exact succession, or until Evacuation HoverJack reaches desired height.
12. Turn off HoverTech International Air Supply, and attach valve caps, if desired and applicable.
13. Move Evacuation HoverJack to desired location.
14. If transferring from the Evacuation HoverJack onto an adjacent surface, unbuckle patient safety straps.
15. If it is necessary to lower patient, slowly open the uppermost valve. When chamber is fully deflated, move in succession downwards to fully deflate. Depress center button for slower deflation.



CHAMBERS MUST BE FULLY INFLATED TO ENSURE STABILITY.



DO NOT RELEASE MULTIPLE CHAMBERS AT ONCE WHEN LOWERING A PATIENT.

Evacuation HoverJack® Instructions for Use as an Evacuation Device

1. To inflate, follow steps 1-11 of instructions for use as an air patient lift.
2. Unzip foot pouch and position Evacuation HoverJack as close as possible to adjacent surface.
3. Transfer patient from bed or stretcher onto Evacuation HoverJack.
4. Ensure that the patient's body is centered, and zip foot pouch.
5. If necessary, inflate the head-end wedge.
6. Using the buckles, secure safety straps over the patient and adjust until taut.
7. Using foot end transport straps and handles located around the perimeter of the Evacuation HoverJack, pull patient to the nearest stairwell, and position the Evacuation HoverJack so the patient can be taken down the stairs feet first.
8. Before descending the stairs, chambers 3 and 4 must be fully deflated. To release air, slowly open valve #4. When chamber #4 is fully deflated, repeat the process for chamber #3. DO NOT RELEASE MULTIPLE CHAMBERS AT ONCE.
9. Retighten patient safety straps after deflating chamber #3 and #4 to ensure patient is secure.
10. Caregiver at head end will control evacuation using head end transport straps. Caregiver at head end should be physically stronger.
11. While 2 caregivers hold the head end transport straps and handles, the footend caregiver will begin to pull the patient down the stairs with the foot end transport strap. The Teflon-infused bottom material will allow the Evacuation HoverJack to slide down each flight. If necessary, the footend caregiver can use their thigh to brace the Evacuation HoverJack and slow the descent. Once at ground level, move the patient to safety.



ENSURE THAT PATIENT REMAINS CENTERED ON THE EVACUATION HOVERJACK, AND THAT THEIR HEAD DOES NOT SLUMP FORWARD AND RESTRICT BREATHING DURING EVACUATION.



A MINIMUM OF THREE CAREGIVERS (TWO AT HEADEND AND ONE AT FOOTEND) SHOULD BE USED TO EVACUATE PATIENT DOWN STAIRS).

HOVERJACK®

Evacuation User Manual

Product Specifications/Required Accessories

Material:	Topside Material: Nylon oxford Underside Material: Teflon®
Construction:	RF-Welded
Width:	32" (81cm)
Length:	72" (183 cm)
Height:	30" (76 cm) Inflated [each chamber 7 1/2" (19 cm)]

Model #: HJ32EV



Weight limit: 1200 lbs (544 kg) for vertical lift.
Weight limit: 700 lbs (318 kg) for stairwell evacuation.

REQUIRED ACCESSORY:

Model #: HTAIR1200 (North American Version) – 120V~, 60 Hz, 10A
Model #: HTAIR2300 (European Version) – 230V~, 50 Hz, 6A
Model #: HTAIR1000 (Japanese Version) – 100V~, 50/60 Hz, 12.5A
Model #: HTAIR2356 (Korean Version) – 230V~, 50/60 Hz, 6A
Model #: Air200G (800 W) (North American Version) – 120V~, 60 Hz, 10A
Model #: Air400G (1100 W) (North American Version) – 120V~, 60 Hz, 10A

HOVERJACK®

Evacuation User Manual

Part Identification – HT-Air® Air Supply

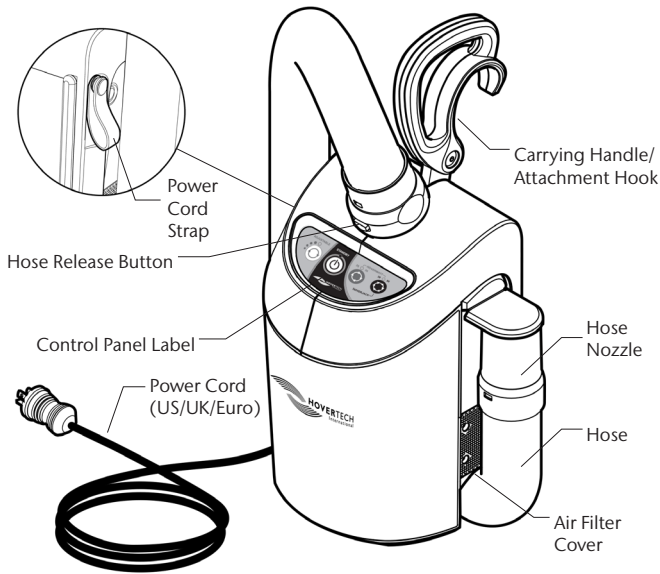

WARNING: The HT-Air is not compatible with DC power supplies.
The HT-Air is not for use with the Hoverjack Battery Cart.

HT-Air® Keypad Functions

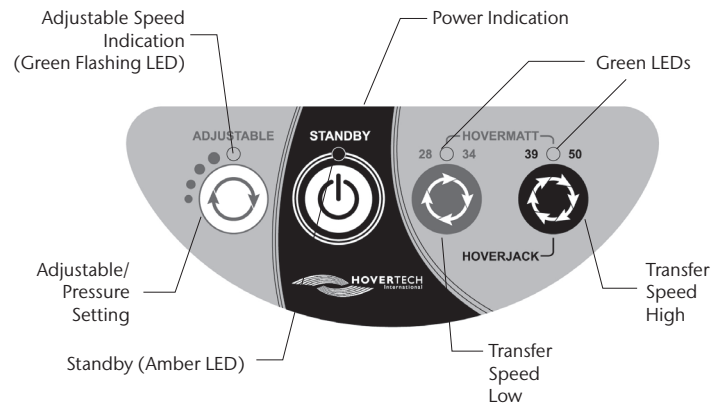

ADJUSTABLE: For use with HoverTech air-assisted positioning devices. There are four different settings. Each press of the button increases the air pressure and rate of inflation. The Green Flashing LED will indicate the inflation speed by the number of flashes (i.e. two flashes equals the second inflation speed).

All of the settings in the ADJUSTABLE range are substantially lower than the HoverMatt and Hoverjack settings. The ADJUSTABLE function is not to be used for transferring.

The ADJUSTABLE setting is a safety feature that can be used to ensure the patient is centered on HoverTech air-assisted devices and to gradually accustom a patient who is timid or in pain to both the sound and functionality of the inflated devices.



STANDBY: Used to stop inflation/air flow (Amber LED indicates STANDBY mode).



HOVERMATT 28/34: For use with 28" & 34" HoverMatts and HoverSlings.



HOVERMATT 39/50 & HOVERJACK: For use with 39" & 50" HoverMatts and HoverSlings and 32" & 39" Hoverjacks.

Air200G/Air400G Air Supplies

If using HoverTech's Air200G or Air400G Air Supplies, press the grey button on the top of the canister to initiate air flow. Press the button again to stop air flow.

Cleaning & Maintenance



EVACUATION HOVERJACK CLEANING INSTRUCTIONS

In between patient use, the Evacuation HoverJack should be wiped down with a cleaning solution used by your hospital for medical equipment disinfection. A 10:1 bleach solution (10 parts water: one part bleach) or disinfectant wipes can also be used. NOTE: Cleaning with bleach solution may discolor fabric.

First remove any visible soil, then clean the area according to the cleaning product manufacturer's recommended dwell time and level of saturation. A gentle scrub brush can also be used on the affected area, if necessary, to help penetrate the Evacuation HoverJack material.



Do not launder the Evacuation HoverJack.

PREVENTIVE MAINTENANCE INSTRUCTIONS

The Evacuation HoverJack should be periodically inspected to ensure the following:

- All patient safety straps are attached.
- Transfer handles are all attached.
- All buckles and zippers are intact and operational.
- There are no punctures or tears.

Evacuation HoverJack with separate inflate/deflate valves:

- Inflate valves are all self-sealing with no evident leakage.
- All deflate valves are equipped with a red cap.
- The red caps are intact.

Evacuation HoverJack with Universal Valves:

Universal valves open fully and close tightly.

AIR SUPPLY CLEANING AND MAINTENANCE

See air supply manual for reference.

NOTE: CHECK YOUR LOCAL/STATE/FEDERAL/INTERNATIONAL GUIDELINES BEFORE DISPOSAL.

Transportation and Storage

This product does not require any special storage conditions

HOVERJACK®

Evacuation User Manual

Returns and Repairs

All products being returned to HoverTech International (HTI) must have a Returned Goods Authorization (RGA) number issued by the company. Please call (800) 471-2776 and ask for a member of the RGA Team who will issue you an RGA number. Any product returned without an RGA number will cause a delay in the repair time.

Returned products should be sent to:

HoverTech International
Attn: RGA # _____
4482 Innovation Way
Allentown, PA 18109

For European companies, send returned products to:



Attn: RGA # _____
Kista Science Tower
SE-164 51 Kista, Sweden

For product warranties, visit our website:

<https://hovermatt.com/standard-product-warranty/>



HoverTech International

4482 Innovation Way
Allentown, PA 18109
www.HoverMatt.com
Info@HoverMatt.com

These products comply with the standards applicable for Class 1 products in the Medical Device Regulation (EU) 2017/745 on medical devices.

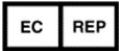

CEpartner4U, ESDOORNLAAN 13,
3951DB MAARN, THE NETHERLANDS.

www.cepartner4u.com



Etac Ltd.

Unit 60, Hartlebury Trading Estate,
Hartlebury, Kidderminster,
Worcestershire, DY10 4JB
+44 121 561 2222



Promefa AG

Kasernenstrasse 3A
Hartlebury, Kidderminster,
8184 Bachenbülach, CH
+41 44 872 97 79

In case an adverse event in relation to the device, incidents should be reported to our authorized representative. Our authorized representative will forward information to the manufacturer.



4482 Innovation Way
Allentown, PA 18109

800.471.2776
Fax 610.694.9601

www.HoverMatt.com
Info@HoverMatt.com